

LW 35222



LEADWARRIOR
HISTORICAL MINIATURE

WWW.LEADWARRIOR.COM
INFO@LEADWARRIOR.COM
Ebay: LEADWARRIOR

FEUERLEITPANZER

fur V-2 Raketen auf Zugkraftwagen 8-ton

Sd.Kfz. 7/3

SUPER - DETAILED EXTERIOR AND INTERIOR

PHOTOETCH SHEET 19 x 7,5 cm.
68 RESIN PARTS

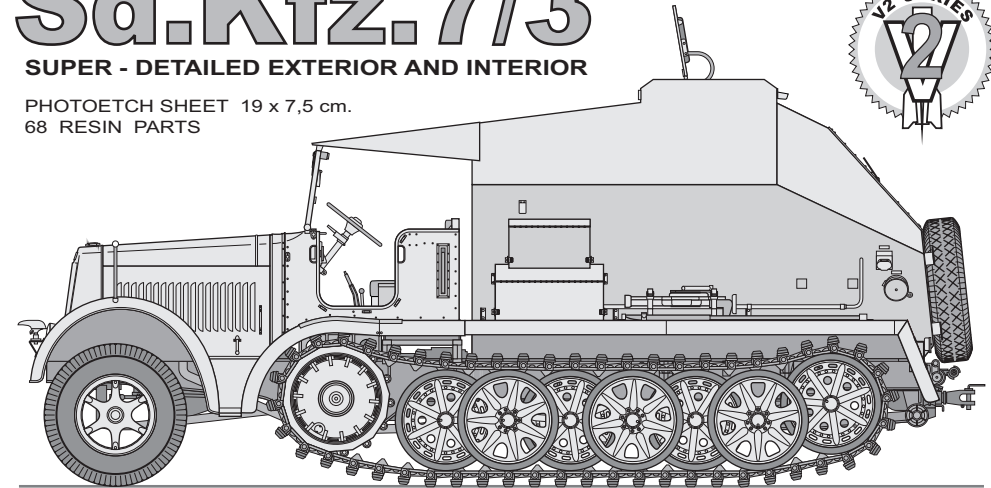

1:35 CONVERSION KIT for DRAGON #6525 Sd.Kfz. 7/1 Flakvierling 38 auf Selbstfahrlafette

In 1944-45, German V-2 missiles were launched from various sites to avoid Allied air attacks. The V-2 launch group had to be, therefore, highly mobile and capable of movement off the road. The firing of up to 8-12 missiles per day by some batteries showed the ruggedness in ingenuity of these units.

There were different types of specialized support vehicles in the V-2 launching units, such as fuel bowsers (Lw35019 and Lw35020 kits), generators, pumps, rocket trailers etc. Some vehicles were adapted from existing Wehrmacht equipment and proved quite compatible.

Thus, the very widely used in German army half-tracked prime-mover Sd.Kfz.7 made by Krauss-Maffei / Daimler-Benz and Bussing and powered by the 115 hp Maybach 'HL 52 TU' engine, converted to the armored launch control vehicle (the Sd.Kfz.7/3 Feuerleitpanzer), became the heart of the V-2 rocket launching units.

The vehicle, having an armored shelter superstructure, mounted on the rear of the half-track, would be positioned about 100 meters from the missile launch pad. The protective measures were intended to shield the crew in case the missile collapsed on the pad and exploded (not uncommon event with the early A-4).

The Feuerleitpanzer had a crew of four: the launch commander, the radio panel engineer, the propulsion unit operator, and the power control operator.

The commander's compartment in the front area of the superstructure was equipped with a telephone communicator, connected to the other members of the launching unit via connectors box, which was mounted on the port board, outside of the vehicle.

Also there was a box with additional electric batteries, and the connectors to supply power and signal to the rocket.

On the starboard side there was a door and a box for instruments and spare parts.

On the march, the Feuerleitpanzer often towed the mobile launching pad (Abschussplattform) on a trailer.

LW 35222

WWW.LEADWARRIOR.COM

INFO@LEADWARRIOR.COM

COPYRIGHT 2015



Sd.Kfz. 7/3
FEUERLEITPANZER
with INTERIOR

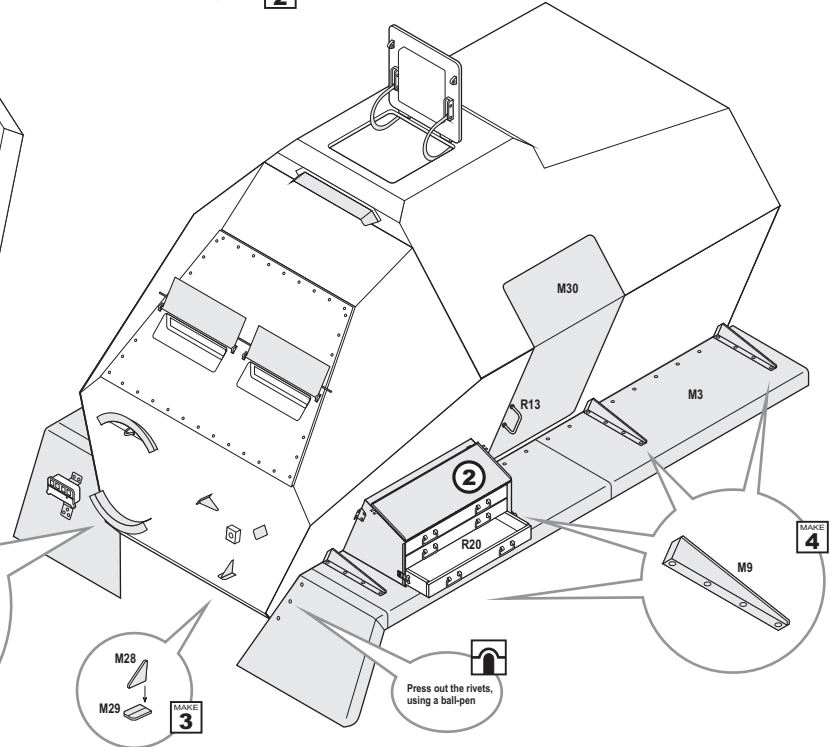
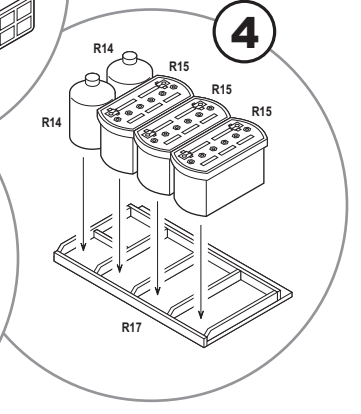
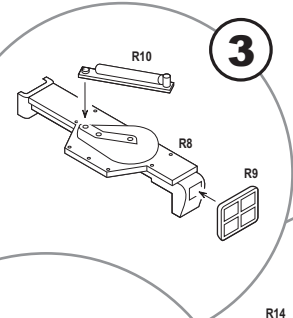
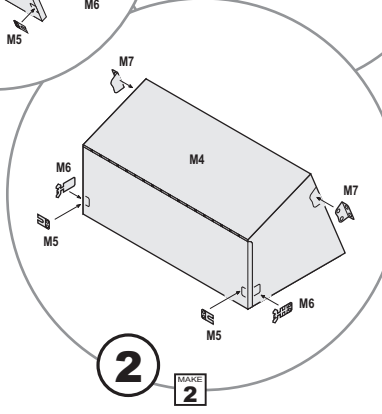
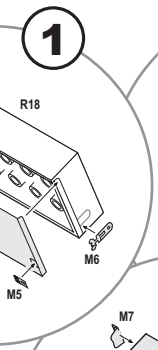
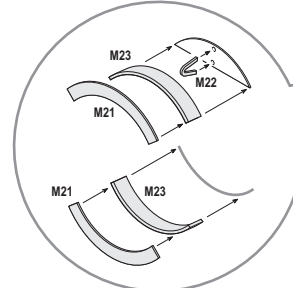
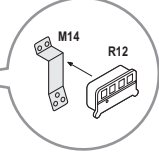
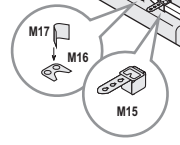
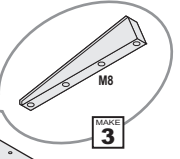
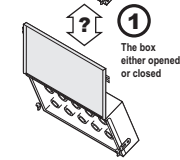
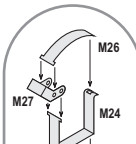
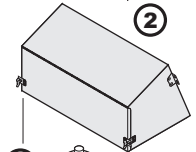
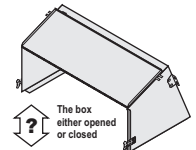
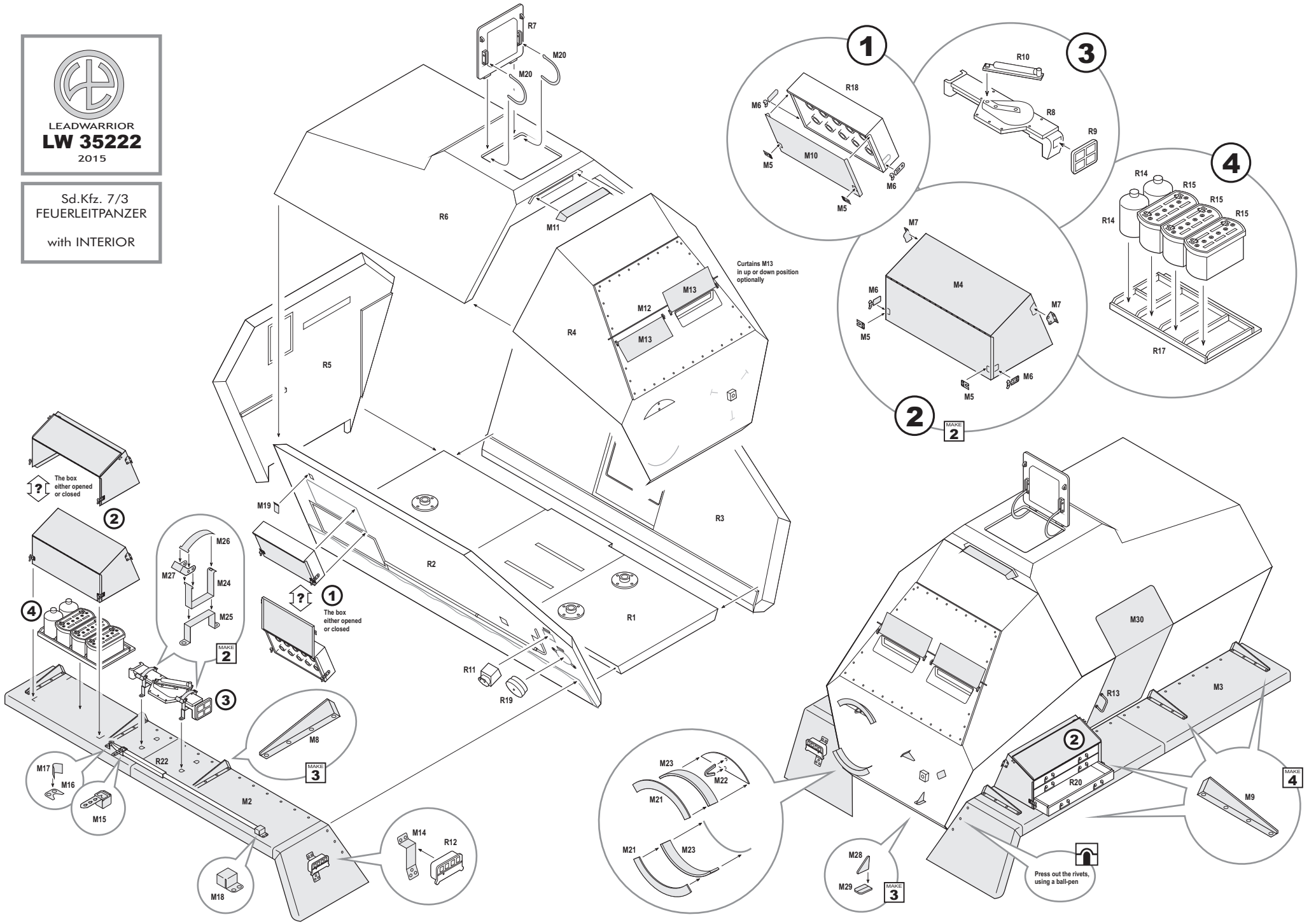

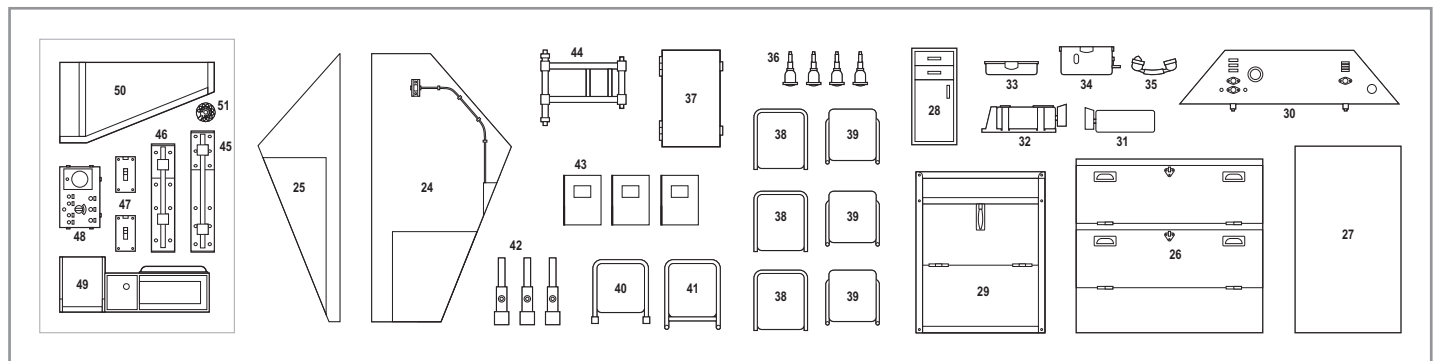
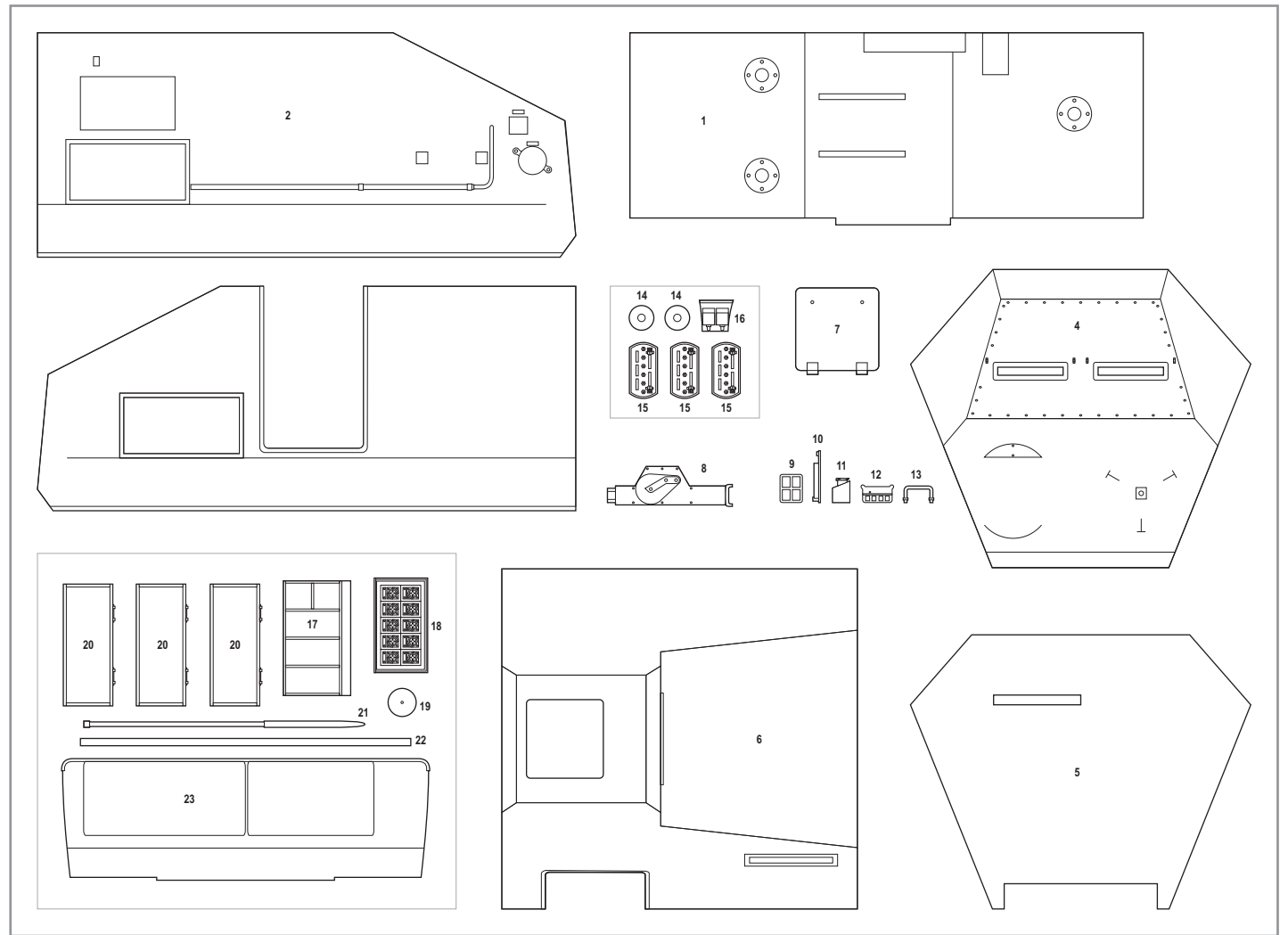
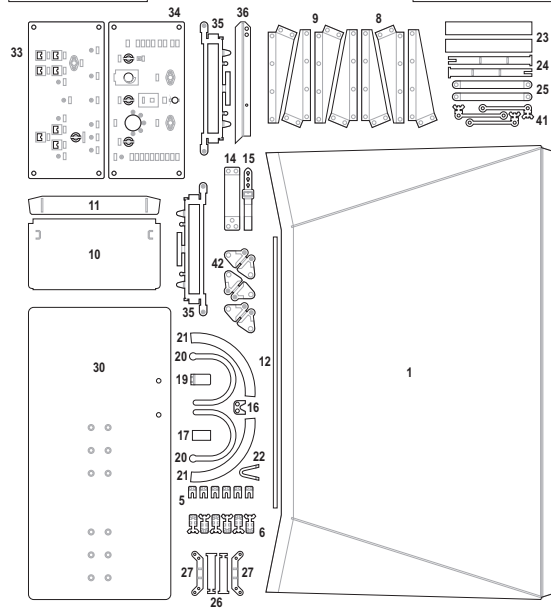
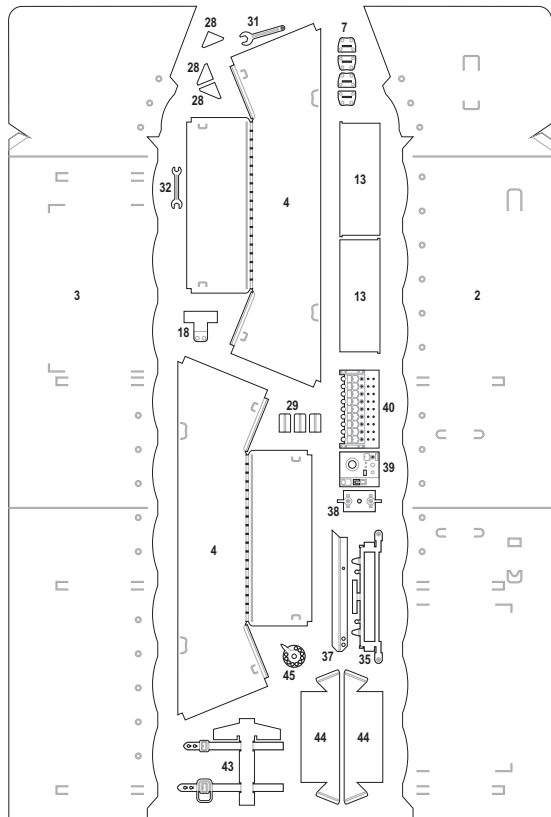

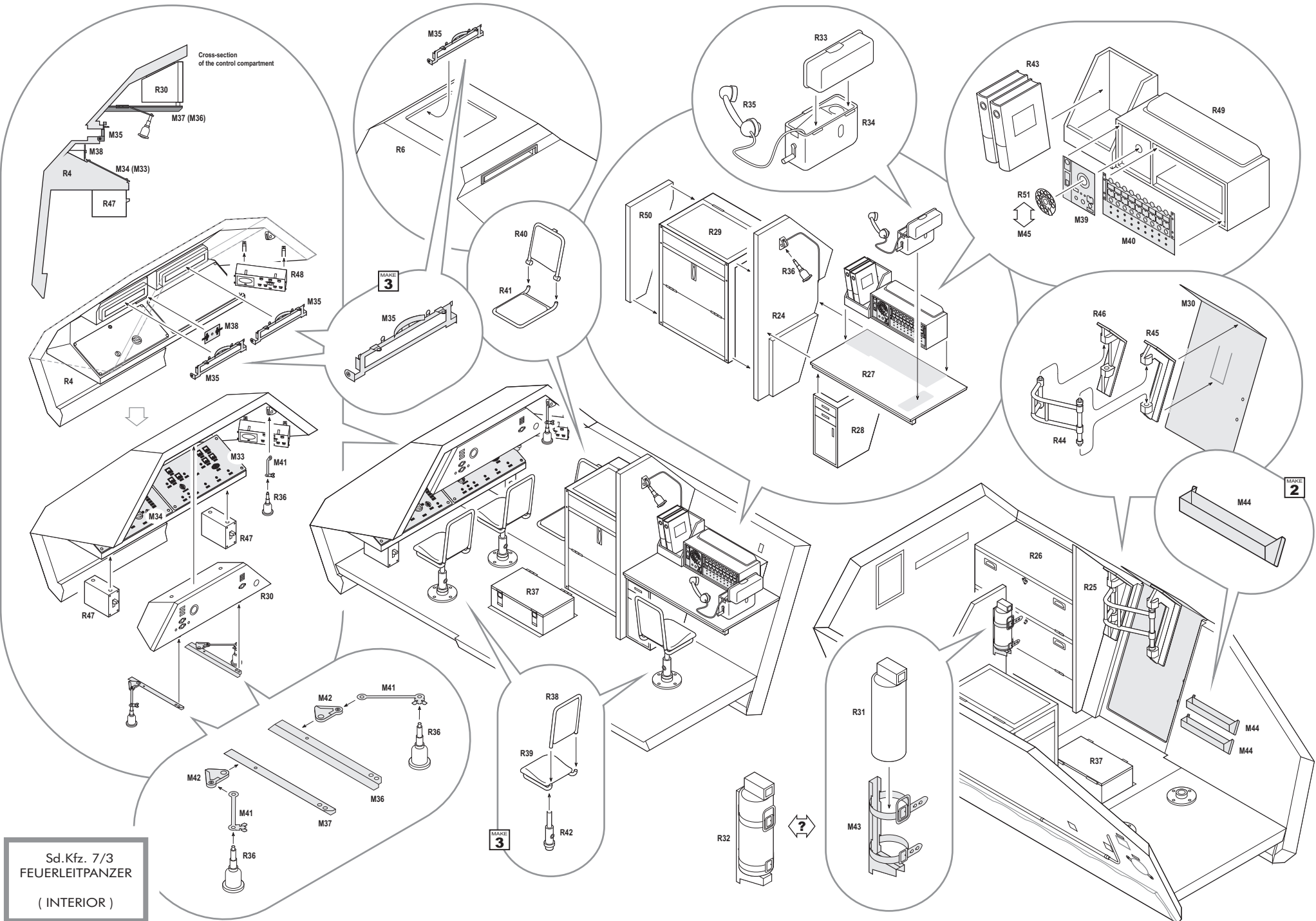

Sd.Kfz. 7/3
FEUERLEITPANZER
(INTERIOR)